

Product: **Window Exhaust Fans**

Catalogue No: **E7WM**



Description: Window Exhaust Fan
with Ball Bearing Motor 175mm

Key Features

- Unobtrusive Design
- Continuous Running
- Economical

Description

These long-life fans are effective alternatives in buildings where ceiling fans cannot be used.

They can be installed quickly and economically in windows with a minimum thickness of 4mm.



Specifications

Size: 175mm diameter

Cut Out Size: 213mm (Dimension C in diagram)

Back Cover: 267mm (Dimension A in diagram)

Depth: 150mm (Dimension B in diagram)

Back Cover
Depth: 28mm (Dimension D in diagram)

Front Cover: 260mm (Dimension E in diagram)

Air Movement: 205m³/HR

AMPs: 0.20

Watts: 22W

Motor: Ball Bearing Motor with Continuous Running

Colour: White Cover

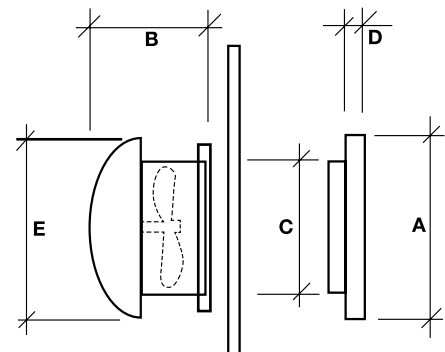

Also Available: In other sizes:
200mm 250mm